

Article number: 23017771124K
 Description: E+G Handwheel
 VR.250 FP-A24-K

Measures

VR.FP-A

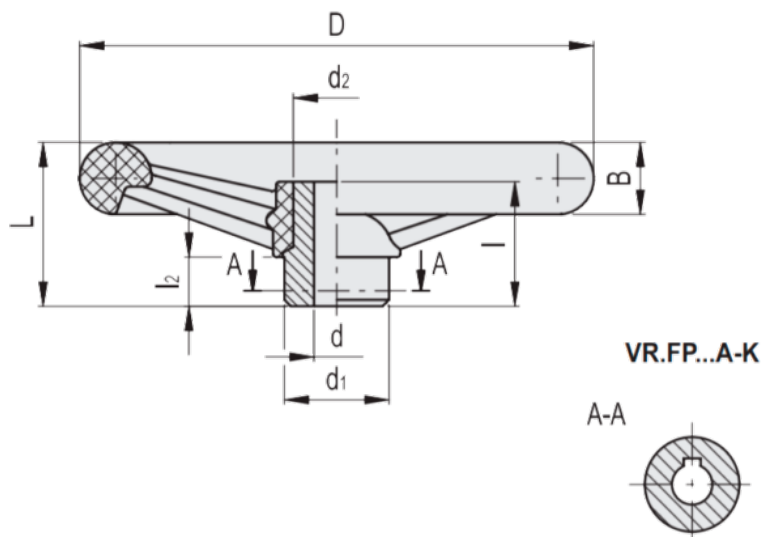

B	= 30	l	= 44
b	= 8	L	= 66
C (N*m)	= 405	L (J)	= 19
D	= 247	l2	= 15
d1	= 49	t	= 27.3
d2	= 38		
d'''	=		
d''''	=		